



SILENT WAVES

Datasheet Traveling Wave Parametric Amplifier

THE ARGO SW2512076A

The Argo is the first Josephson traveling wave parametric amplifier from Silent Waves. Our architecture combines high gain, wideband, and ultra-low noise amplification without any DC current or magnetic flux bias. It is ideal for ultra-low power signal detection and qubit readout. The amplifier is powered by a microwave source (not provided).



Contents

Setup for operating the TWPA	3
How to use the TWPA	5
Characteristics at 20 mK	6
Box schematic	10

Setup for operating the TWPA

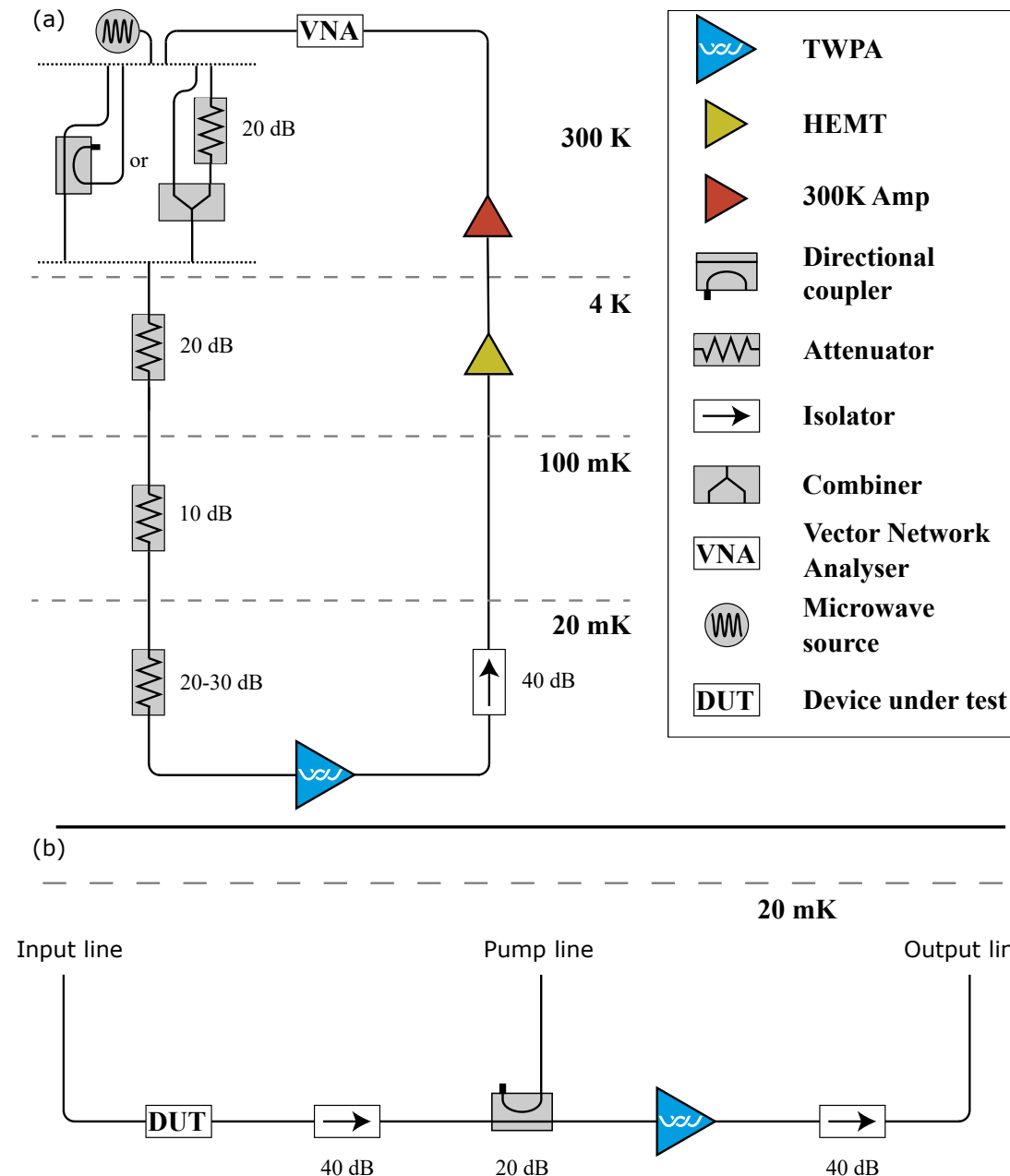

Figure 1: Typical setups for testing/using the TWPA. (a) Ideal setup for testing the TWPA. (b) TWPA in a readout line (at the mixing chamber stage). Note: always verify the directional coupler specifications to see which port is coupled to which port.

Fig. 1(a) shows an ideal setup for testing the TWPA to verify if its specifications match those on the datasheet. A microwave source (acting as the pump) and a VNA can be combined at room temperature using either a splitter or a directional coupler (with 20 dB coupling). The

amount of attenuation and isolation is optimized to minimize the thermal noise reaching the TWPA. Reducing attenuation and isolation increases the risk of saturating the TWPA with thermal noise.

Fig. 1(b) shows a setup where the TWPA is used for the readout of a device under test (DUT). It is possible to test the TWPA by bypassing the DUT and sending the pump tone and the VNA tone through the pump line, combining them at room temperature as in Fig. 1(a). To optimize the performance of the TWPA, the cables between all the elements between the two isolators should be as short as possible. All the microwave components should be anchored to a copper piece to be well thermalized. Before installing the TWPA, it is a good habit to test your setup by replacing it with a cable or a through connection to detect any problems in your readout line. Keep in mind that the attenuation on the input and pump lines should be comparable to those in Fig. 1(a).

TWPA Safety Measures:

The TWPA is sensitive to electrostatic discharges (ESD), so precautions must be taken to avoid damaging it. Here is a list of steps to follow in order to limit the risk of ESD:

- When modifying the setup at the mixing chamber stage, first disconnect the TWPA and put 50-ohm terminations.
- When all the modifications are done, the TWPA should be the last element to connect.
- Before plugging something into the TWPA, make sure to discharge the inner pin:
 - Put a 50-ohm termination on the cable that you want to connect to the TWPA.
 - Remove the 50-ohm termination from the TWPA.
 - Remove the 50-ohm termination from the cable.
 - Plug in the cable.
 - Then repeat the procedure for the second cable that will connect to the other connector of the TWPA.
- When the TWPA is not connected to any experiment, make sure to put the 50-ohm terminations on the SMA connectors.

How to use the TWPA

The spatially modulated TWPA works by engineering the dispersion relation to fulfill the phase matching condition between the pump, the signal, and the idler, which is essential for optimal TWPA performance. By spatially modulating the size of the Josephson junctions, a photonic gap is created, which appears as a significant dip in transmission during TWPA spectroscopy. For this device, the photonic gap opens around 7.175 GHz and is approximately 0.46 GHz wide. To achieve phase matching, the pump frequency must be close to the gap frequency, on the lower frequency side. Finding the optimal pump frequency and pump power combination can be challenging, as the gap frequency will slightly shift towards lower frequencies as the pump power increases. The procedure is as follows:

- Set the pump to low power (-90 dBm at the input of the TWPA) and its frequency at the edge of the gap.
- Start increasing the pump power: you should first see some gain and then a drop. Keep that power level.
- Lower the pump frequency: again, you should see some gain and then a drop as you continue decreasing it.
- Repeat the last two steps incrementally until you reach the maximum achievable gain.

Alternatively, an easy solution is to measure the gain versus pump power and pump frequency (using 0.2 dBm pump power steps and 5 MHz pump frequency steps). Keep in mind that even after finding the best gain profile, the most effective way to optimize the TWPA is to measure your device directly and determine which pump parameters yield the best results.

Characteristics at 20 mK

Before shipping the TWPA devices, they were characterized in a dilution fridge reaching a base temperature of 20 mK. The following section presents the characteristics of the TWPA. Most of the results should remain valid up to at least 100 mK.

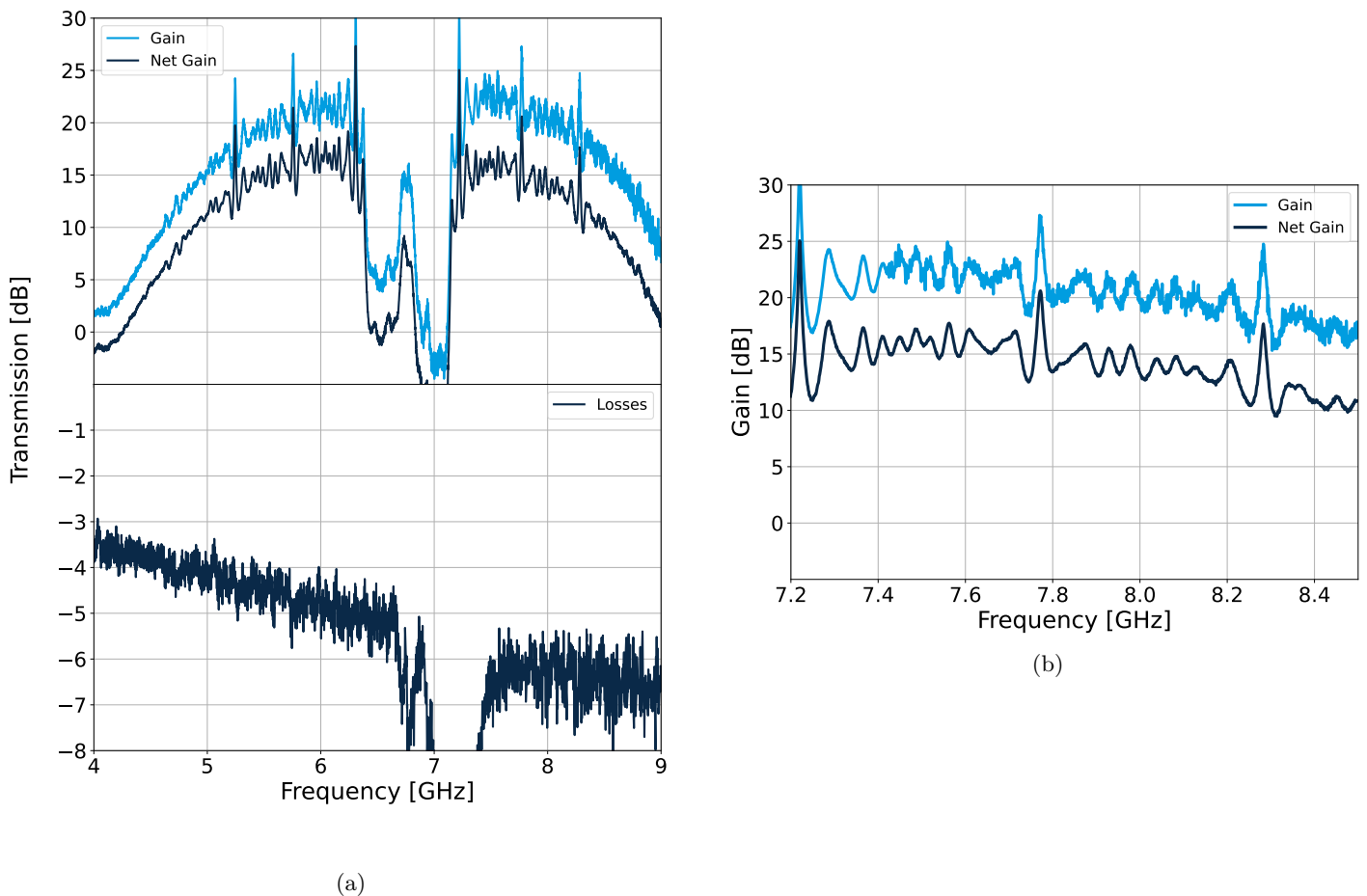

Figure 2: (a) **Top panel** shows the gain (ON-OFF) and net gain (ON-lossless reference) of the TWPA. The pump parameters are (at the input of the TWPA): 6.76405 GHz and -63.9 dBm. **Bottom panel** shows the electrical losses within the TWPA. The gap is centered at 7.175 GHz and is 0.46 GHz wide, the signal cannot propagate in the gap. (b) Zoom on the gain curve.

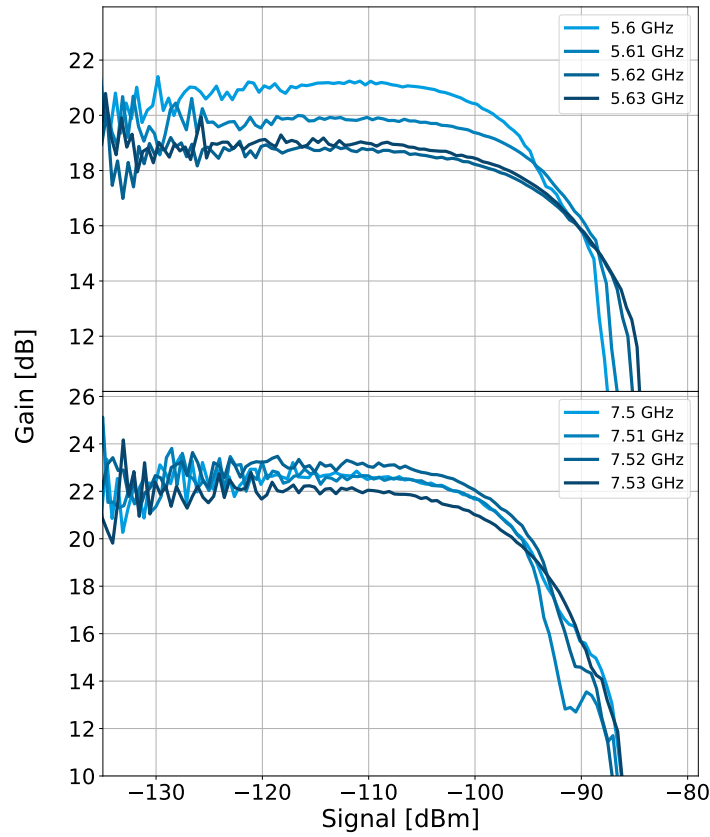

Figure 3: Graph of several saturation curves. The signal power corresponds to the signal at the input of the TWPA.

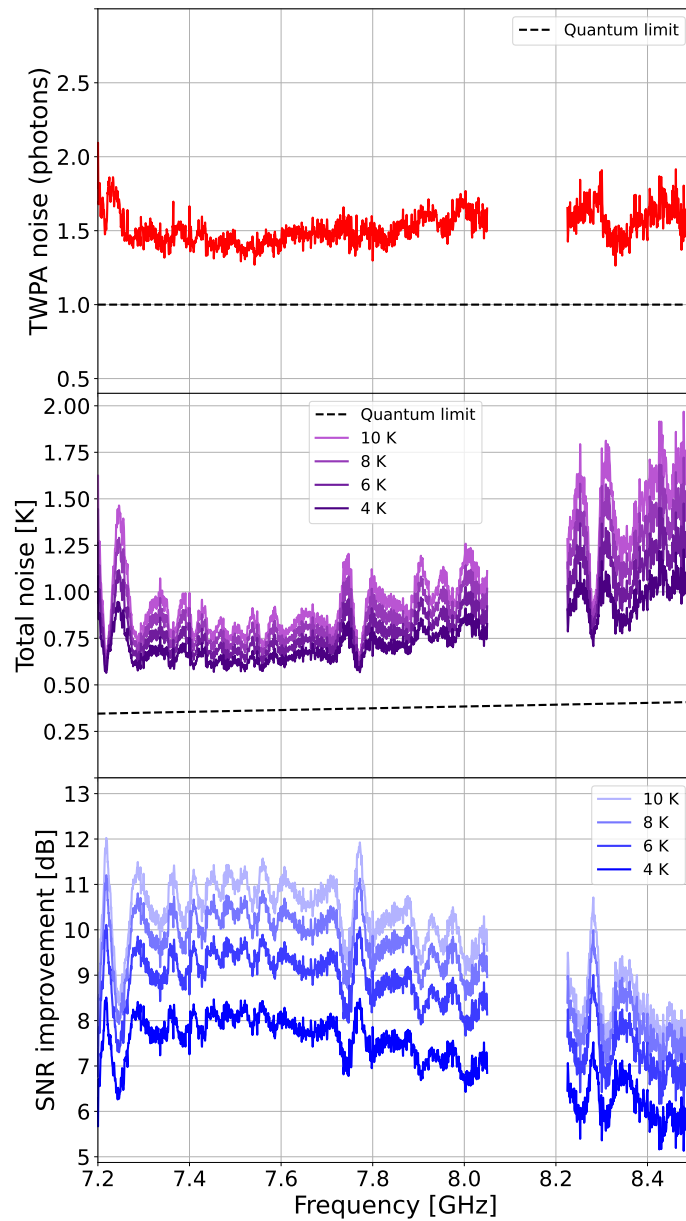

Figure 4: **Top panel:** Intrinsic noise of the TWPA. **Middle panel:** Total noise of the readout line with the TWPA for various initial readout line noise levels (10 K, 8 K, 6 K, 4 K without a TWPA). **Bottom panel:** Corresponding SNR improvement.

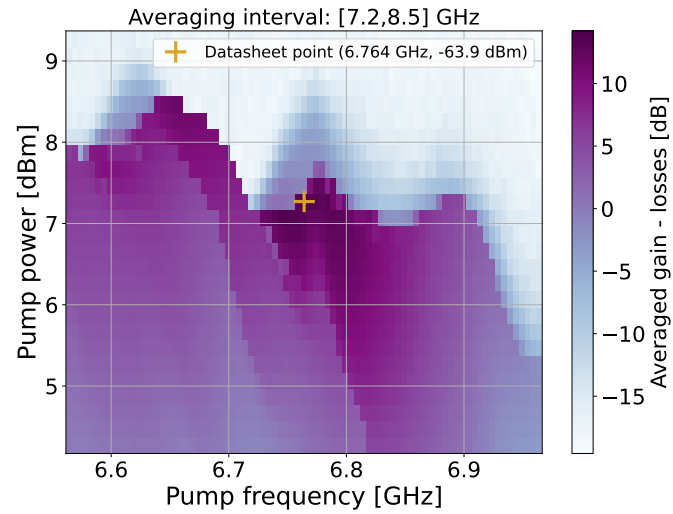

Figure 5: Averaged gain of the TWPA referred to a through line as a function of the pump frequency and the pump power (at the output of the pump source). The operating point used for the other figures in the datasheet is indicated by the yellow marker (with the pump power specified at the input of the TWPA).

Box schematic

The TWPAs are shipped already packaged in a gold-plated copper sample holder with two SMA connectors. The TWPA can exhibit asymmetry depending on which connector is used as the input. To ensure the connection is consistent with the datasheet, we marked the lid with input and output. The sample holder must be anchored to the base temperature plate of the cryostat (using a copper bracket, for example).

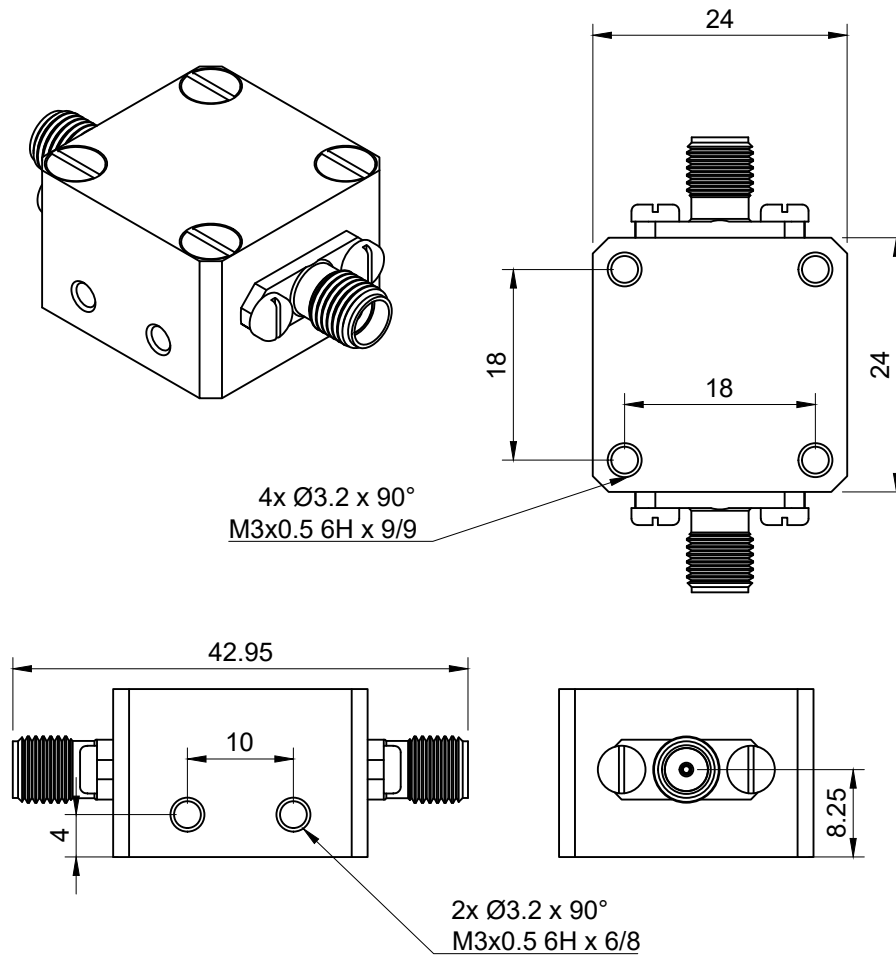

Figure 6: Schematic of the box