

# QMC-CRYOBRD-02SiC



## Dilution Refrigerator Breadboard Sample Measurement System

### Description

**QMC-CRYOBRD-02SiC** is a versatile, full-package cryogenic breadboard designed for the most demanding low-temperature experiments. Precision-machined from gold-plated OFHC copper, it delivers excellent thermal performance and long-term durability. A near-light-tight architecture combines cryogenic mu-metal shielding to suppress magnetic and electromagnetic interference. The innermost sample space features an infrared gold-plated copper shield with a Stycast/C/SiC IR-absorbing coating. A fully non-magnetic interior with 16 non-magnetic SMA bulkhead feedthroughs enables flexible, high-density signal routing. Designed to mount directly to the mixing-chamber flange of most dilution refrigerators, QMC-CRYOBRD-02SiC offers a turnkey solution for ultra-low-noise cryogenic research.

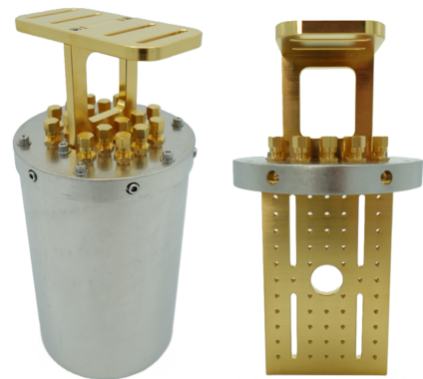

QMC-CRYOBRD-02SiC

### Key Features

- 16x SMA nonmagnetic bulkhead feed-thrus
- 16x nonmagnetic SMA caps to shield ports which are not in use
- Breadboard consists of 52X M3 threaded holes, and 4x M3 screw clearance slots for flexibility in mounting samples
- Magnetic shielding includes Amuneal A4k shield.
- Gold plated infrared inner shield with Stycast/C/Sic coating to absorb stray photons
- Durable Nickel-free gold plating on all copper parts
- DC feedthrough options available

### Drawings

- Full height - 8.81 in
- Weight – 7 lbs (3.2 kg)
- M4 screw Mounting to mixing chamber

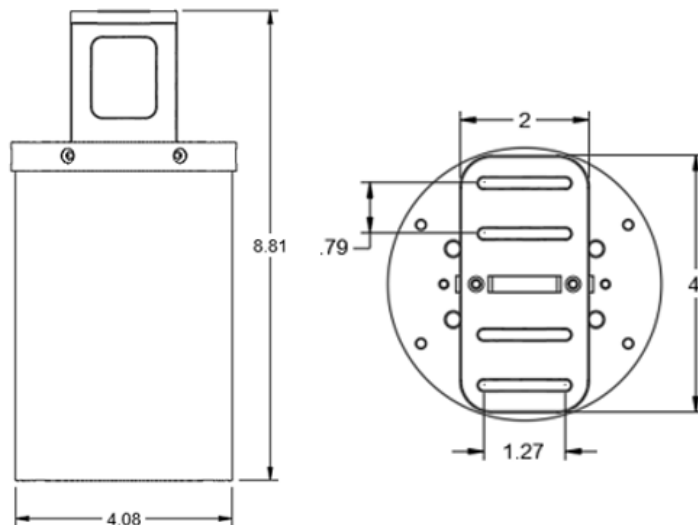

# QMC-CRYOBRD-02SiC

Dilution Refrigerator Breadboard  
Sample Measurement System

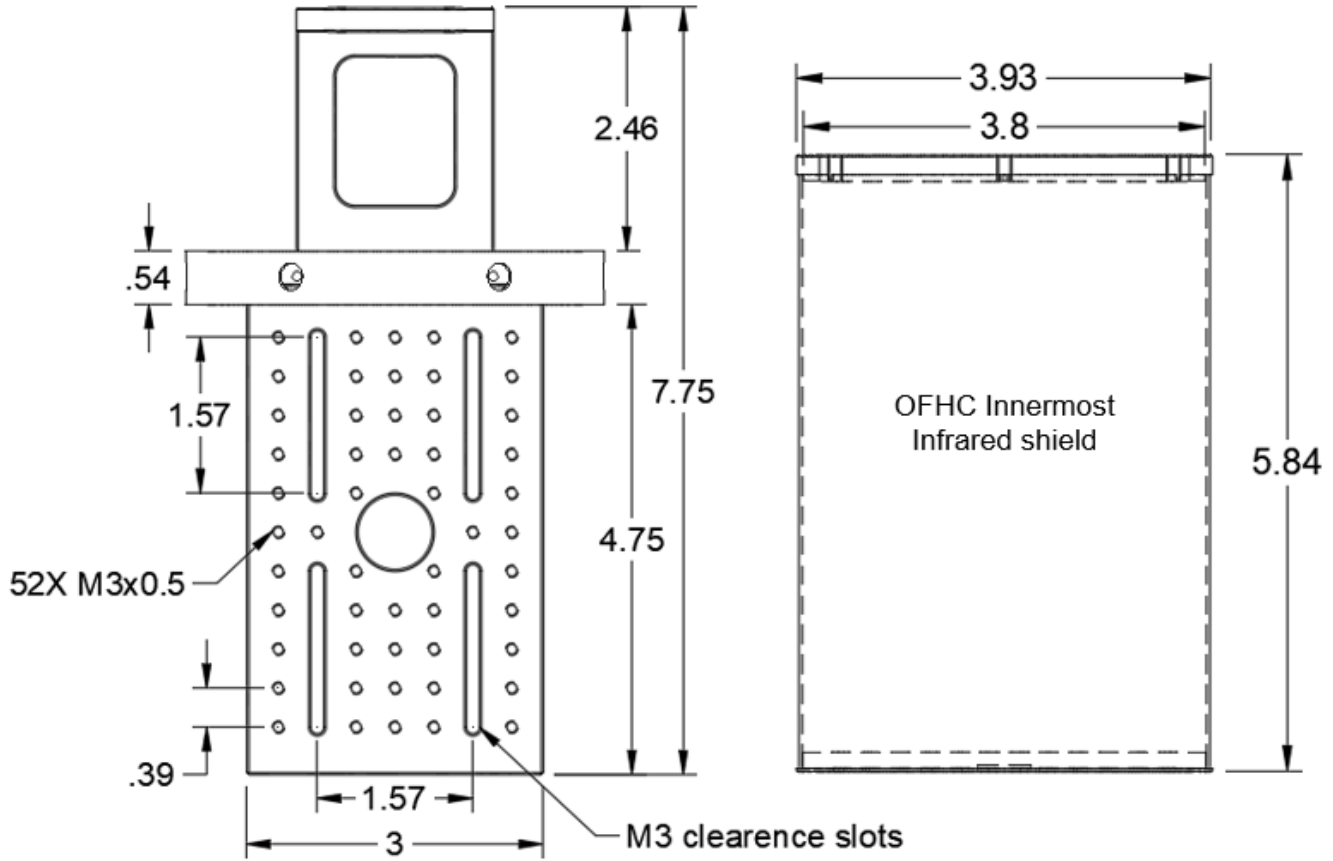

## Shielding

- 3.8" ID OFHC Copper Infrared Shield
- Stycast/Carbon Powder/SiC Inside Coating of Infrared Shield
- Amuneal A4K 0.04" Mu-metal magnetic shield

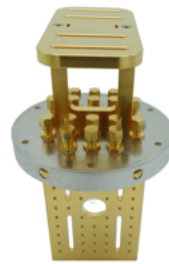

OFHC Copper  
Infrared shield with  
Stycast/SiC coating



Amuneal A4K magnetic  
shield

# QMC-CRYOBRD-02SiC

## Dilution Refrigerator Breadboard Sample Measurement System

### Breadboard

- Breadboard material OFHC copper with hard durable gold plating with thickness of 30 microinches.
- Breadboard consists of 52X M3 threaded holes, and 4x M3 screw clearance slots for flexibility in mounting samples.



### Mounting

- Breadboard system can be mounted to a mixing chamber flange of a dilution refrigerator through 4x M4 clearance slots allowing for flexibility in mounting position of measurement system. Clearance slots are offset by 2 cm for easy mounting to hole patterns found in most dilution refrigerator systems.

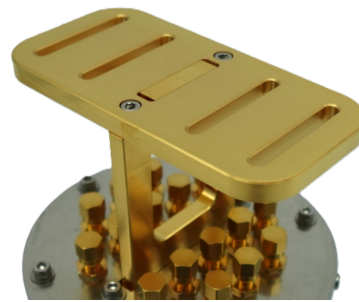

### Feed-thru

- 16X 1/4-36 threaded holes for SMA feed-thrus, bulkhead attenuators, bulkhead filters, or DC feed-thrus into sample space
- Included - 16X non-magnetic SMA feed-thrus (QMC-CRYOCON-BLKMAFTI)
- Included - 16X non-magnetic SMA caps (QMC-CRYOCAP) for RF shielding of unused ports



16x 1/4-36 threaded feed-thru

### Cryogenic Attenuator Feed-thru:

- (Optional) SMA feed-thrus can be replaced with QMC bulkhead cryogenic attenuators in dB (0, 3, 6, 10, 20, 30) QMC-CRYOATTF-XXBLK

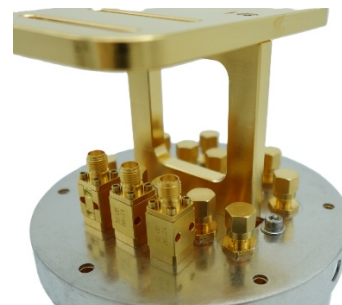

(Optional) QMC-CRYOATTF-XXBLK  
Attenuator feed-thru

# QMC-CRYOBRD-02SiC



## Dilution Refrigerator Breadboard Sample Measurement System

### Infrared Filter Feed-thru

- (Optional) SMA feed-thrus can be replaced with QMC high and low cutoff frequency Infrared bulkhead filters (QMC-CRYOIRF-001, QMC-CRYOIRF-002, QMC-CRYOIRF-003, or QMC-CRYOIRF-004)



(Optional) QMC-CRYOIRF-XXX  
Infrared filter feed-thru

### DC Feed-thru (4-pin)

- (Optional) DC feed-thru which puts a 4-pin LEMO connector in a 1/4-36 feed-thru port.
- SMA cap (QMC-CRYOCAP) can be used on DC feed-thru port for RF shielding of unused port.



(Optional) 4-pin DC feed-thru

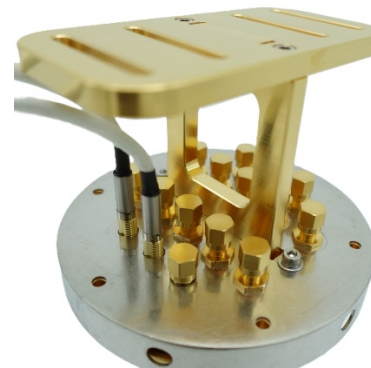

(Optional) 4-pin DC feed-thru (top view)

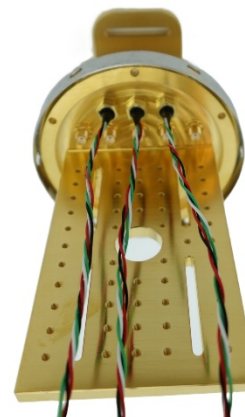

(Optional) 4-pin DC feed-thru (bottom view)

# QMC-CRYOBRD-02SiC



## Dilution Refrigerator Breadboard Sample Measurement System

### DC Feed-thru (9-pin)

- (Option) DC feed-thru which puts a 9-pin Omnetics nanoD connector in a 1/4-36 feed-thru port.



(Optional) 9-pin Omnetics nanoD DC feed-thru



(Optional) 9-pin nanoD DC feed-thru (top view)

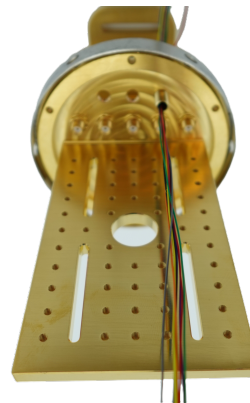

(Optional) 9-pin nanoD DC feed-thru (bottom view)

### Venting Options

- To speed up pump down of sample space, included venting options:

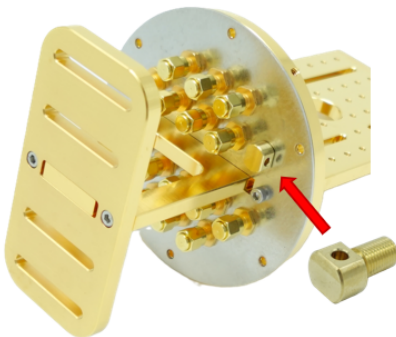

- Vent port can be added in a SMA feed-thru position to vent innermost sample space inside infrared shield.

## Dilution Refrigerator Breadboard Sample Measurement System

### Performance Test - Transmon Measurement

The shielding performance of the QMC sample measurement breadboard system was characterized with a Conscience QiBo transmon qubit.

The QiBo was first characterized without shielding in a Bluefors LD250 dilution refrigerator with mixing chamber infrared shield provided by Bluefors. All holes in the mixing chamber plate were blocked with plates and screws. The QiBo was bolted directly to the mixing chamber plate. The measurement lines had standard attenuation and Eccosorb IR filters, QMC 004MF on the input line and QMC 003MF on the output readout line at the mixing chamber. The results of unshielded energy relaxation measurements of the transmon qubit are shown in Figure 1 (blue squares).

Shielded measurements of the same QiBo qubit bolted to the breadboard of the QMC sample measurement breadboard system which was mounted to the mixing chamber of the dilution refrigerator were performed in a separate cooldown. Measurements of the QiBo shielded with the light-tight OFHC infrared shield, aluminum superconducting shield, and mu-metal magnetic shield were performed with the same measurement line configuration and room temperature instruments as the unshielded case. The QiBo energy relaxation measurements show over a 3-fold improvement, Figure 1 (red circles).

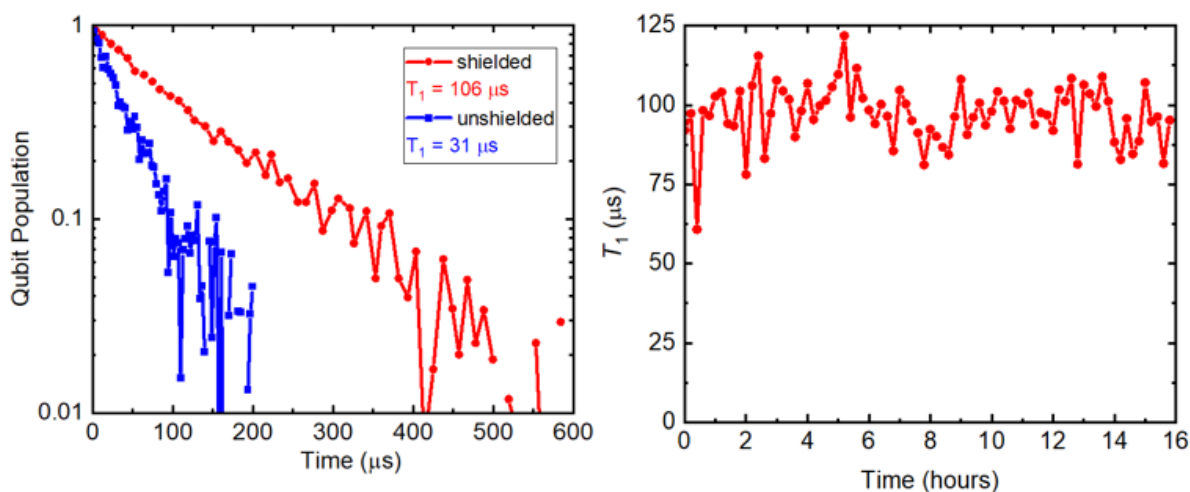

Figure 1 (left panel) Energy relaxation measurements of the Conscience QiBo transmon qubit performed unshielded (blue circles) and shielded (red squares) with the QMC sample measurement breadboard system. (right panel) Measurements of energy relaxation  $T_1$  vs time showing the stability of the transmon qubit over 16 hours.