



Specifications:

- Crystalline Quartz Cryogenic Attenuator
- Non-Magnetic
- Capable of operation at 10mK
- Attenuation: 0 dB
- Frequency: DC to 18 GHz
- Return Loss: -23 dB
- Max Power: 100mW
- Connectors: SMPS Female
- NiCr on crystalline 5 mil quartz
- Non-superconducting microstrip pad
- Stackable mechanical design
- Housing: Gold Plated OFHC Copper
- All connector varieties available in male and female:
- 2.92 mm, SMA, SMP, SMPM, SMPS
- All connectors are field replaceable and swappable



Parameter	Specification	Notes
Frequency Range	DC to 18 GHz	
Attenuation Setting @5GHz	+/- 0.5 dB or +/-5% (greater of)	
Insertion Loss variation with frequency	<1.0 dB	
Return Loss, all models	-23 dB typical	
Connectors	SMPS Female	
Max Power Handling	100 mW	

Made in the USA

✉ Sales@QuantumMicrowave.com

Measured Data (typical)

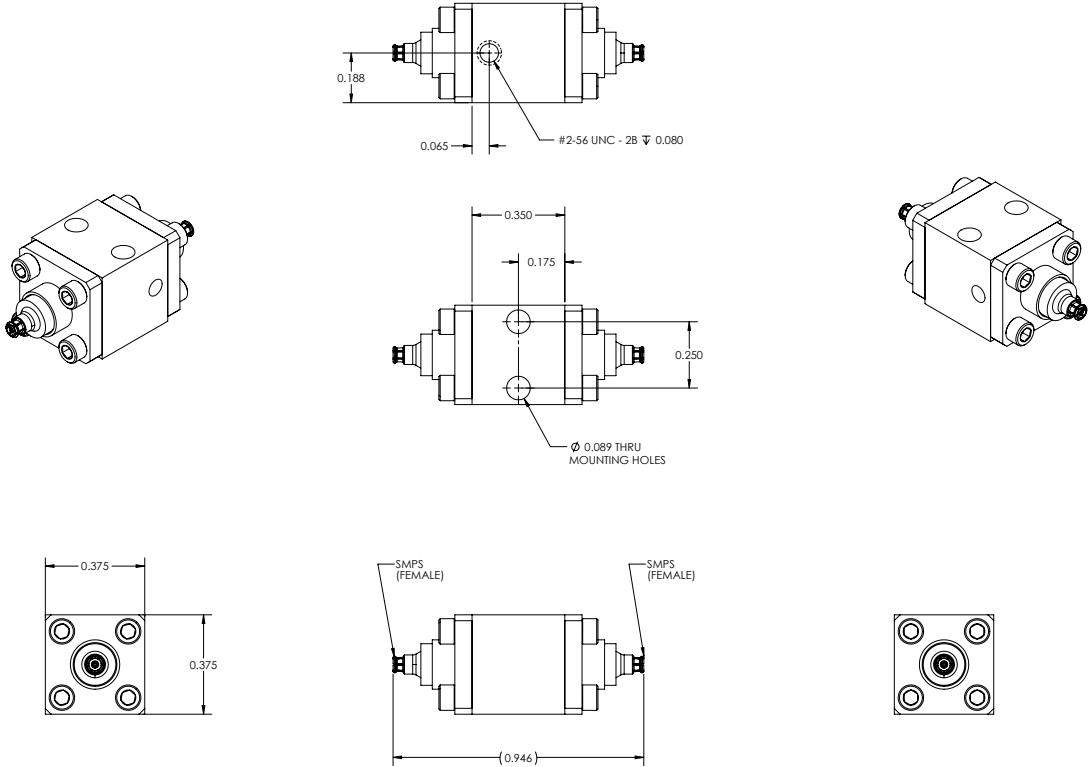
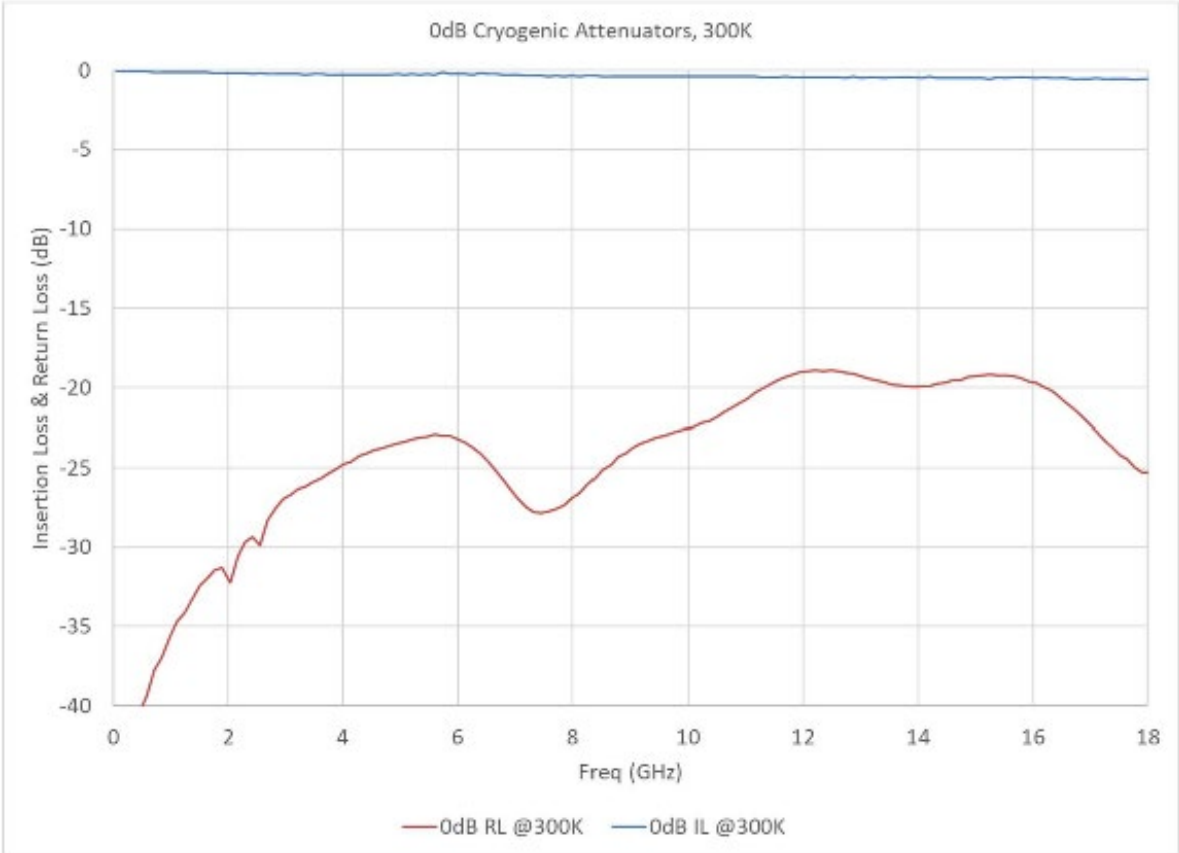

Made in the USA
 Sales@QuantumMicrowave.com