



QMC22-ATT06
QuantumMicrowave.com

Specifications:

- WR-22 Fixed Attenuator
- Frequency: 33 to 50 GHz
- Attenuation: 6 dB
- Power: .5 W typical, .75 W max
- Attenuation variation: 1 dB typical
- Length: 3.5 inches
- Waveguide: WR-22, UG-383/U
- Material: OFHC Copper Waveguide
- 360 Series Brass Flanges
- Finish: Gold Plated



All of our attenuators are high quality, plated with gold and offered at an affordable cost.

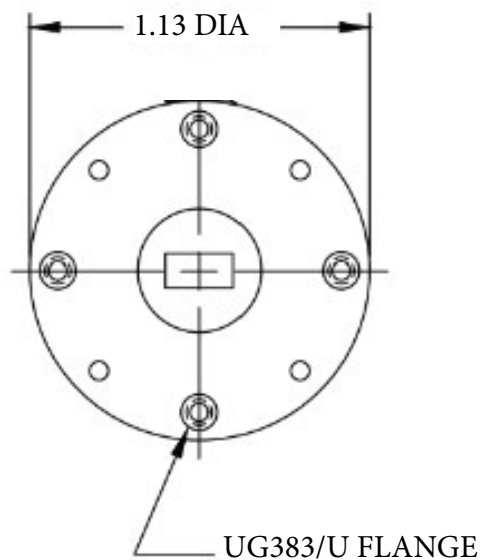

Made in the USA

✉ Sales@QuantumMicrowave.com