

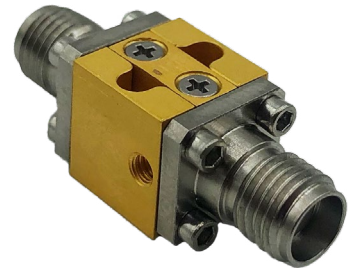

Specifications:

- Crystalline Quartz Cryogenic Attenuator
- Capable of operation at 10 mK
- Attenuation 6 dB
- Frequency: DC to 18 GHz
- Return Loss: -23 dB typical
- Connectors: SMA F on Both Sides
- Max Power: 100 mW
- Housing Gold Plated OFHC Copper
- NiCr on thermally conductive dielectric
- Non-superconducting microstrip pad



Parameter	Specification	Notes
Frequency Range	DC to 18 GHz	
Attenuation Setting @5GHz	+/- 0.5 dB or +/-5% (greater of)	
Insertion Loss variation with frequency	<1.0 dB	
Return Loss, all models	-23 dB typical	
Connectors	SMA Female on Both Sides	
Max Power Handling	100 mW	

Made in the USA

✉ Sales@QuantumMicrowave.com

Measured Data (typical)

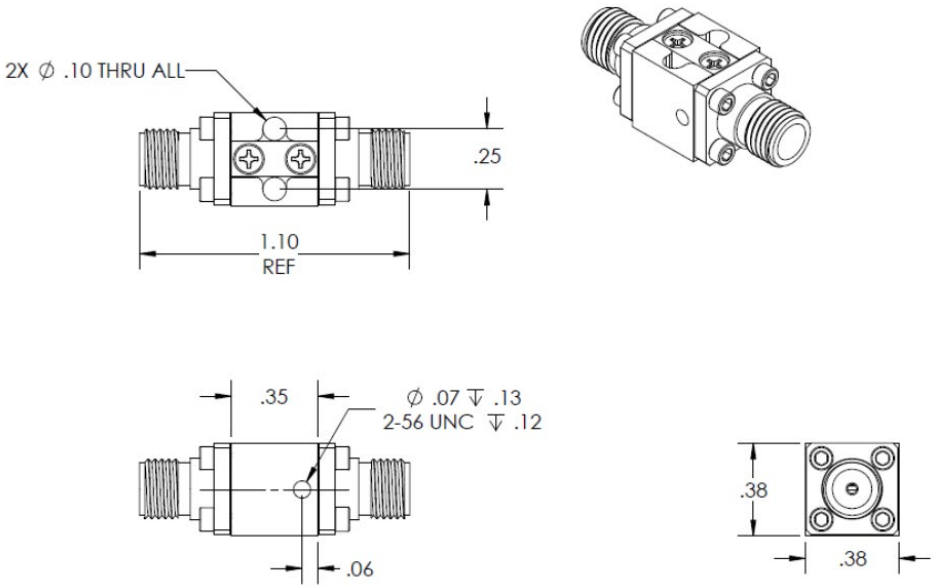
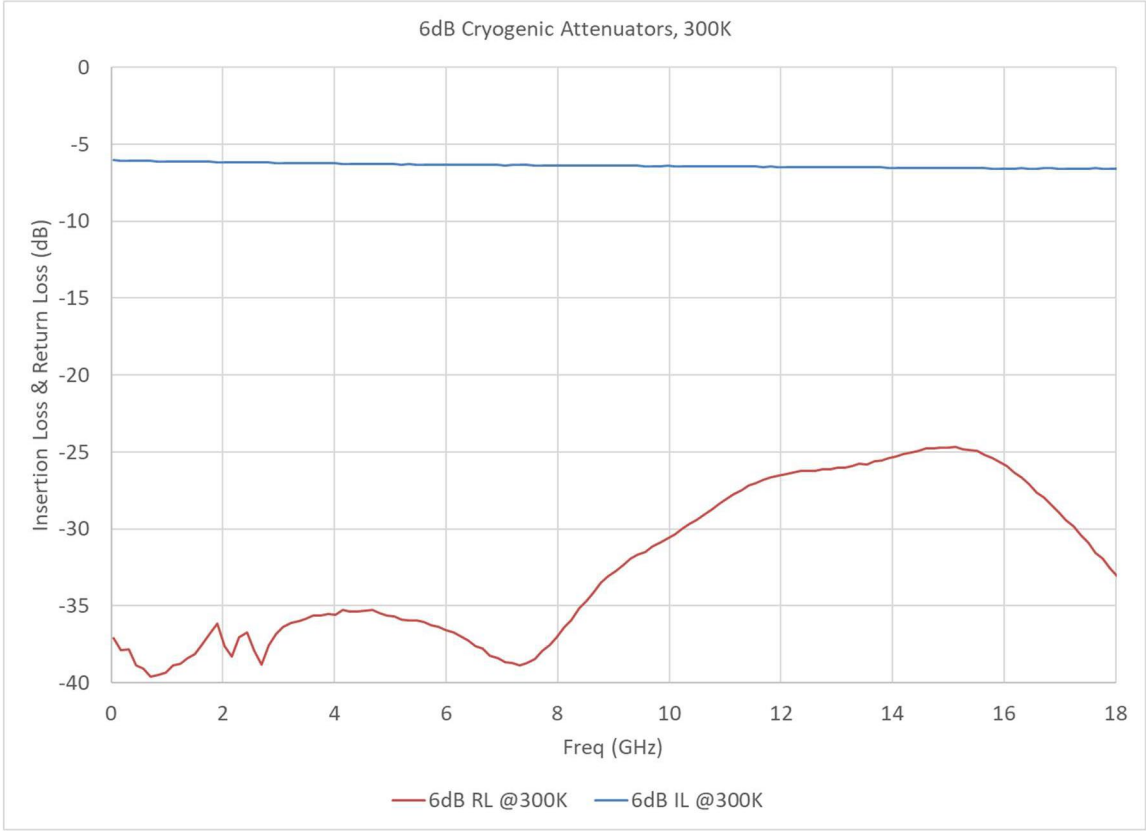

Made in the USA

✉ Sales@QuantumMicrowave.com