

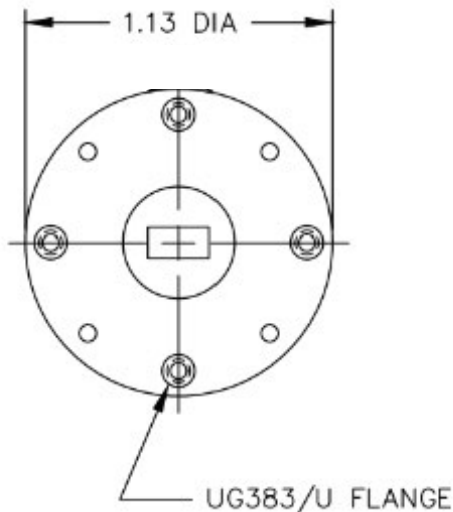

Specifications:

- WR-22 Pyramidal Gain Horn
- Frequency: 33 to 50 GHz
- Height: 1.66 in
- Length: 4.07 in
- Width: 2.17 in
- Gain: 23 dBi typical
- VSWR: 1.1:1
- Return Loss: 23 dB typical
- Waveguide: WR-22, UG-383/U
- Round Brass Flanges
- Gold Plated Electroformed Version

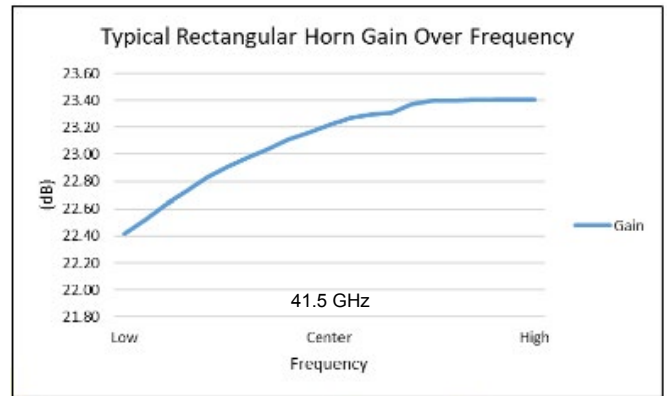
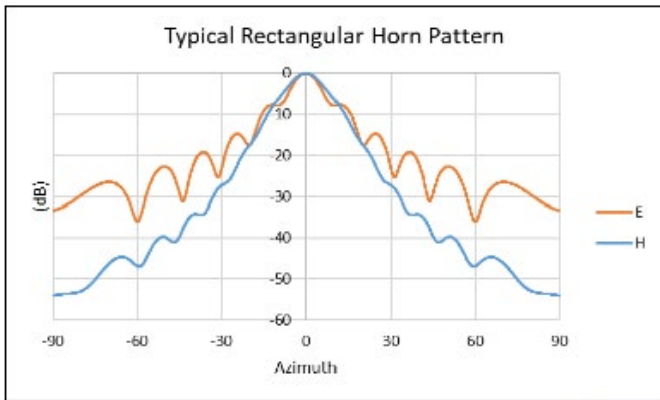
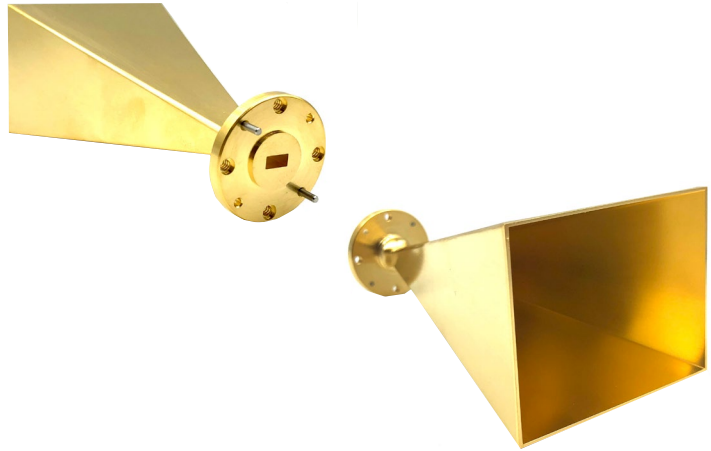

Made in the USA

✉ Sales@QuantumMicrowave.com