

Datasheet

LNF-xxxxxC4_12A

4-12 GHz Cryogenic Triple Junction Isolator or Circulator



LNF-ISISISC4_12A

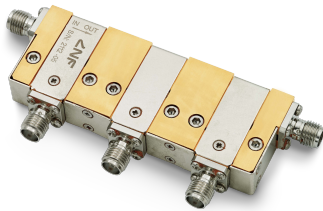

LNF-CICICIC4_12A

Product Features

RF Bandwidth	4-12 GHz
Insertion Loss at 5 K	0.5 dB typical
Insertion Loss at 77 K	0.5 dB typical
Isolation	60 dB typical
Port Match	18 dB typical
RF Connectors	Female SMA

Absolute Maximum Ratings

Parameter	Min	Max
Operating Temperature	0.01 K	100 K
RF Drive Level		30 dBm
DC Voltage on RF Input and Output	-50 V	50 V

Typical RF Characteristics at 77 K

Parameter	Condition	Value	Unit
Insertion Loss	4-12 GHz	0.5	dB
Isolation	4-12 GHz	60	dB
Port Match	4-12 GHz	18	dB

LNF-xxxxxC4_12A is ultra-low insertion loss cryogenic isolator/circulator operating in the 4-12 GHz frequency range. They have been designed from ground up to meet the strict requirements of ultra-low temperature physics research. The gold plated OFHC copper body ensures minimum loss and that this loss reaches the lowest possible temperature to minimize thermal noise. The isolator/circulator is packaged in a slim coaxial module using industry standard SMA connectors. The module measures 67.06x24.64x10.16 mm excluding the connectors.

Measured data, $T_{amb} = 77\text{ K}$

Insertion Loss at 77 K

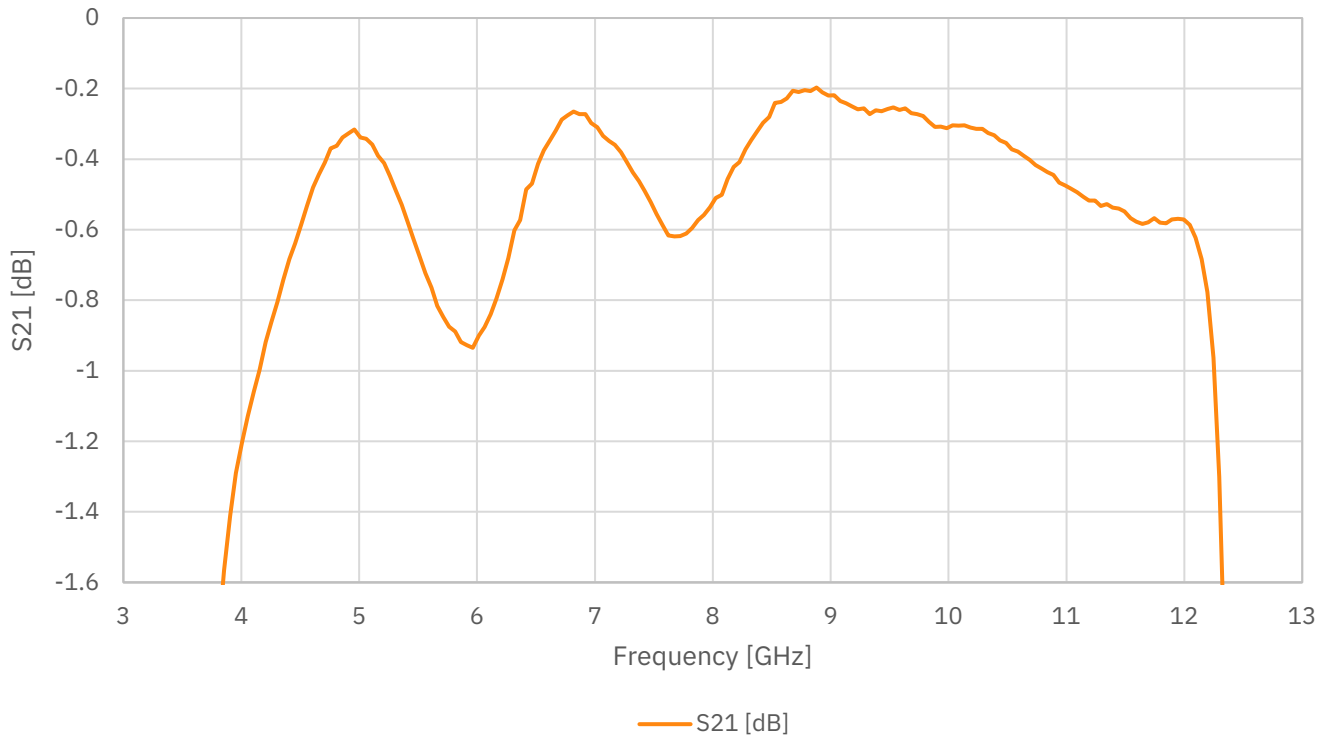

Isolation at 77 K

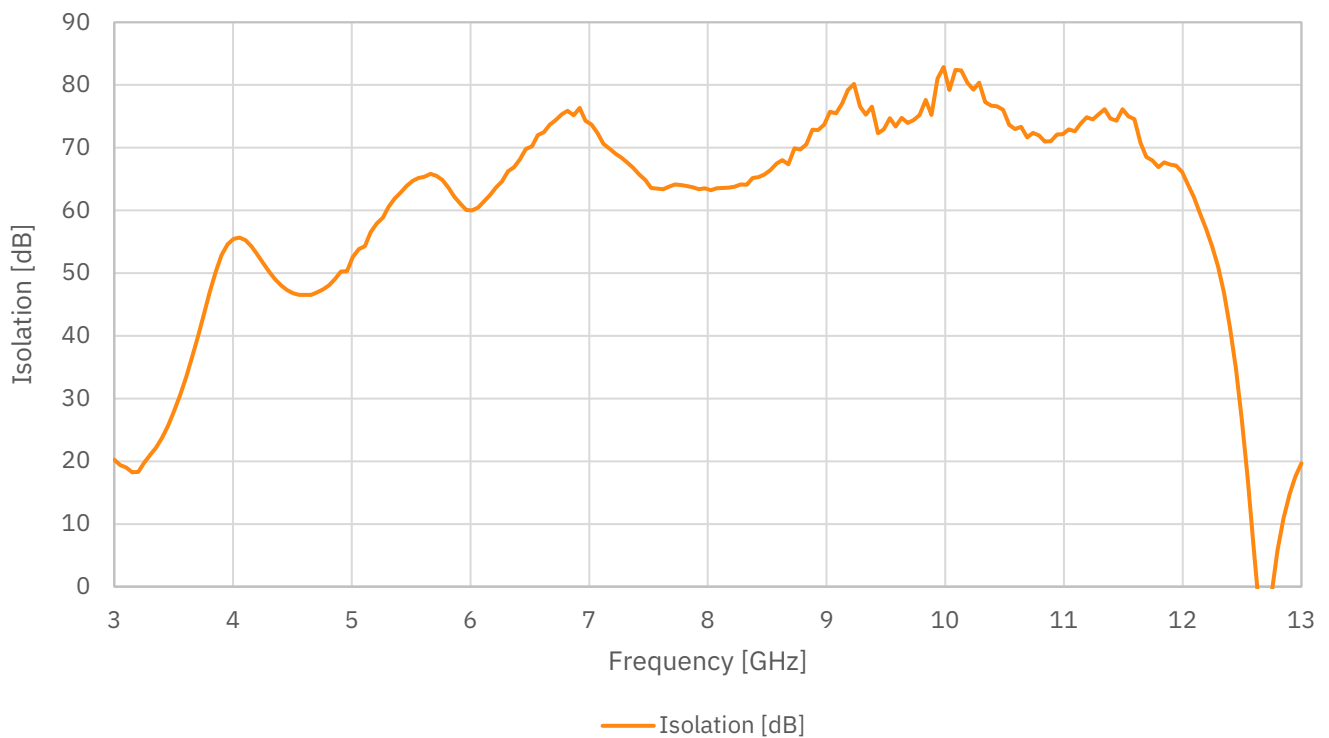

Port Match at 77 K

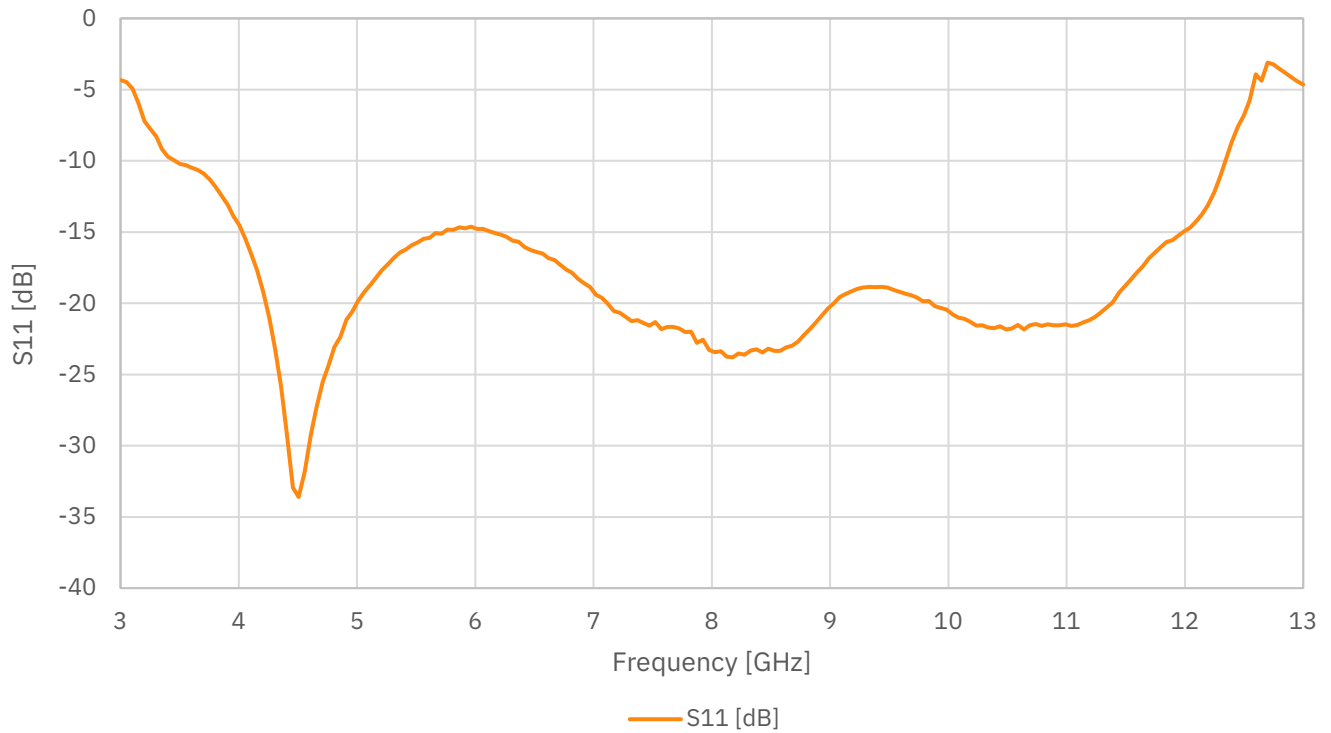

Measured data, $T_{amb} = 5\text{ K}$

Insertion Loss of 4 Units at 5 K

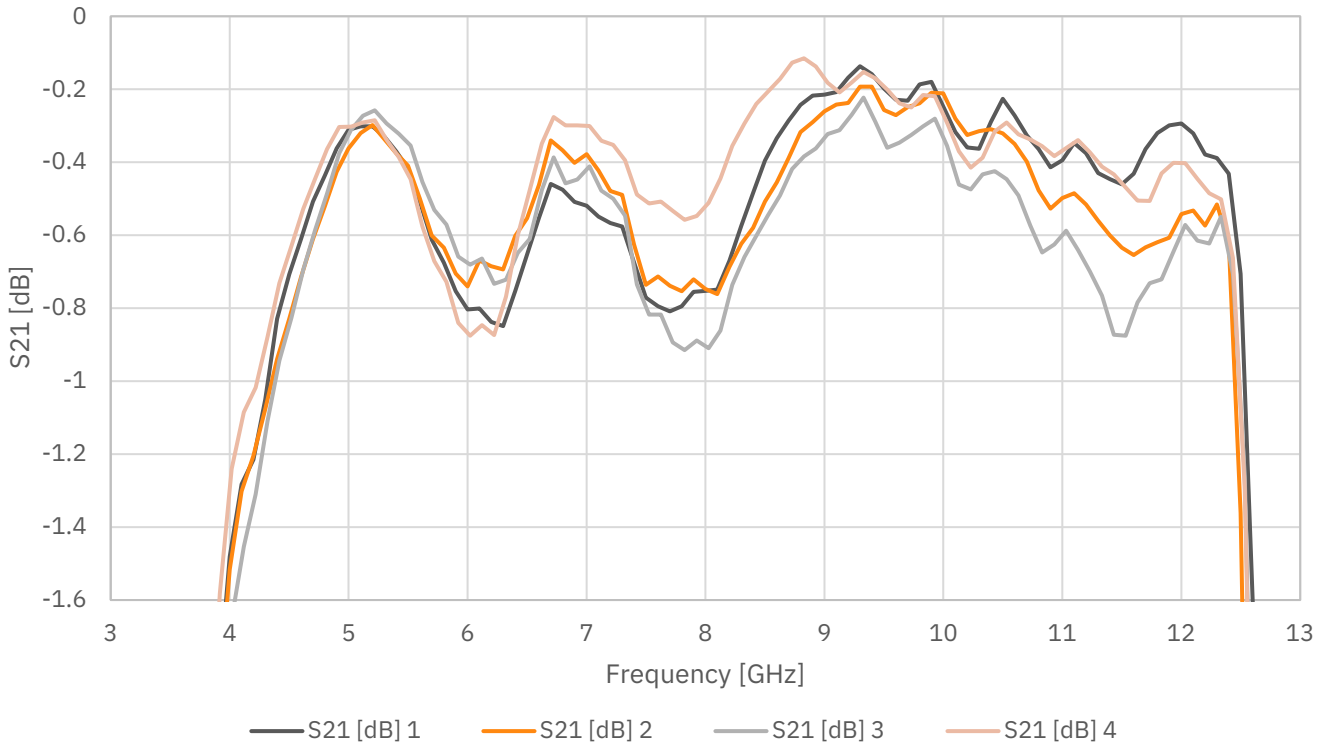

Isolation of 4 Units at 5 K

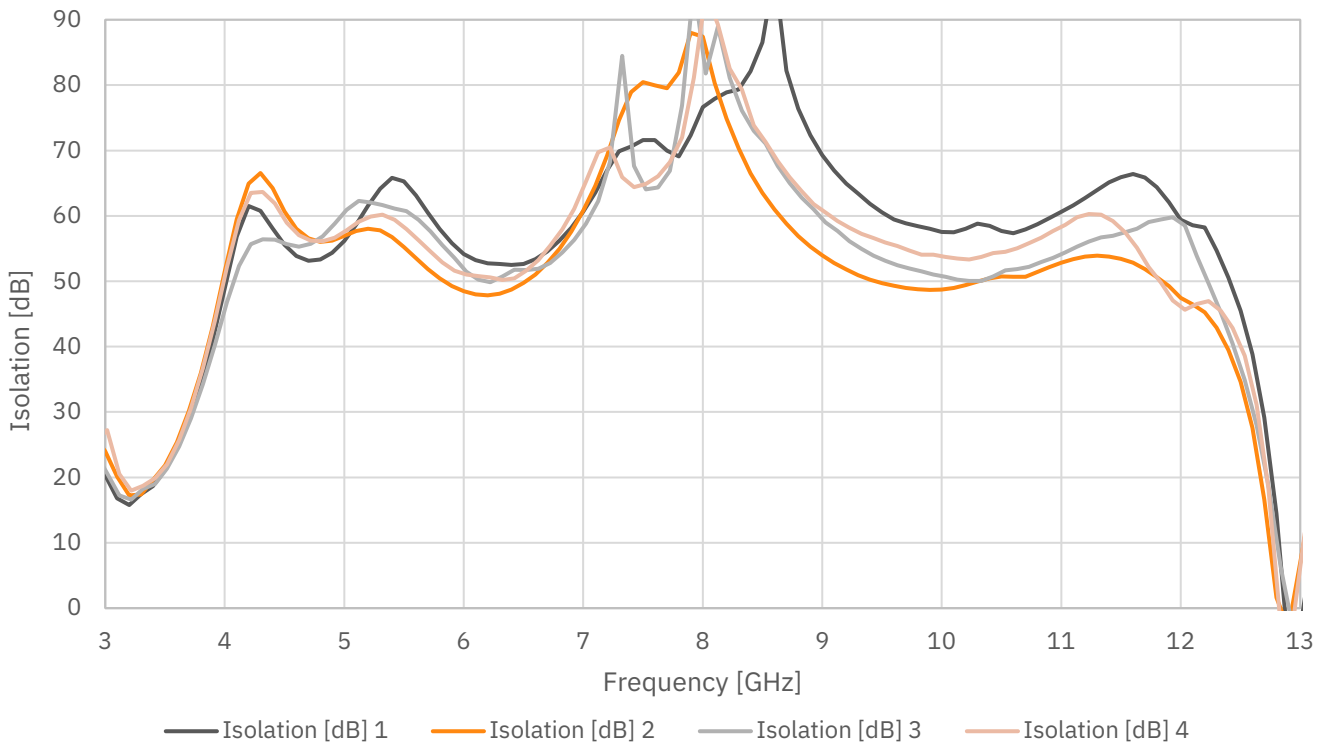

Port Match of 4 Units at 5 K

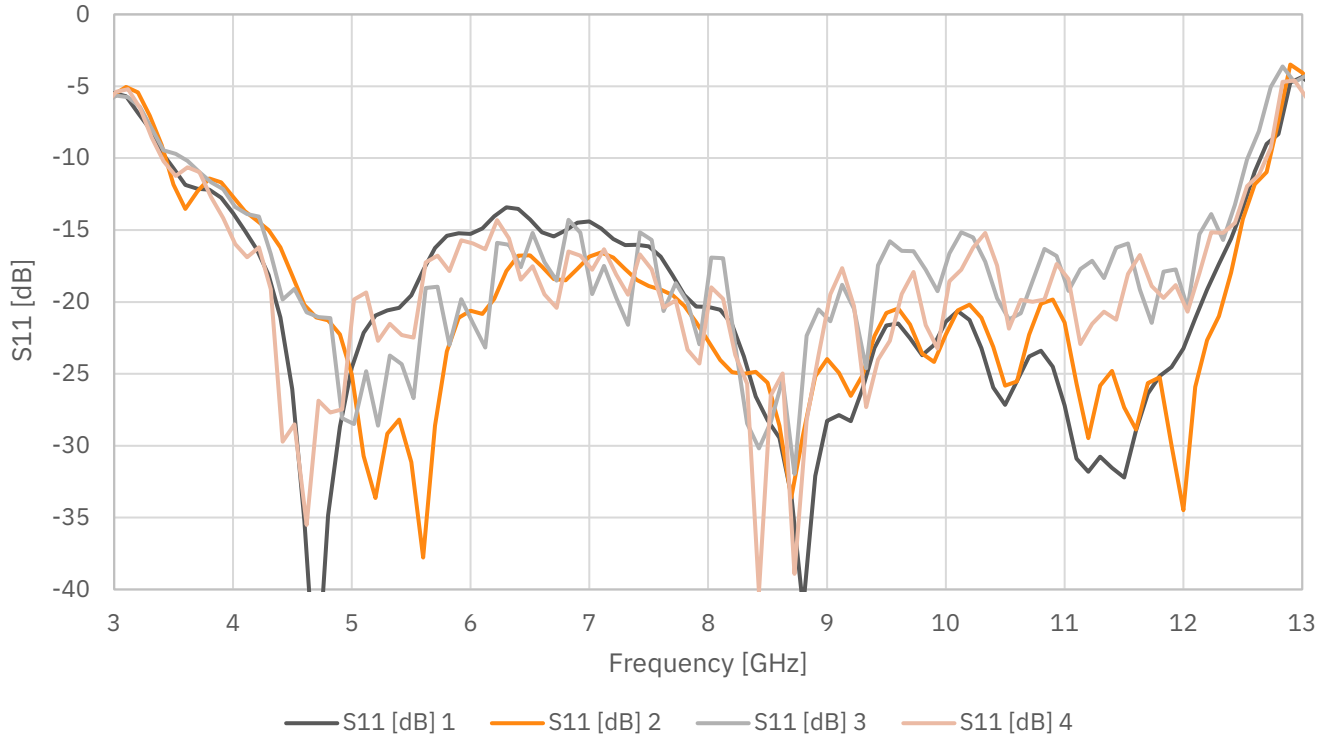

Magnetic flux density generated by internal magnet

Parameter	Condition	Value	Unit
Magnetic flux density with standard shielding*	6 mm from chassis	< 4	Gauss
Magnetic flux density with optional shielding	6 mm from chassis	< 0.1	Gauss

- This is the magnetic field generated by the internal magnet inside the isolator/circulator chassis, which potentially may influence nearby components.
- Two isolators/circulators can be placed 3.3 mm apart without interfering with each other.

Maximum external magnetic field imposed on the isolator

Parameter	Condition	Value	Unit
Maximum perpendicular external magnetic field	At chassis	650	Gauss
Maximum parallel external magnetic field	At chassis	1500	Gauss

- “Maximum field” means the field when the passband frequency edge has shifted 150 MHz, and insertion loss degradation becomes noticeable.
- The optional MuMetal shield improves the maximum external magnetic field very little. MuMetal alloys are good at shielding very low level “stray” magnetic fields, however the material saturates quickly and doesn’t shield well against high field external sources.

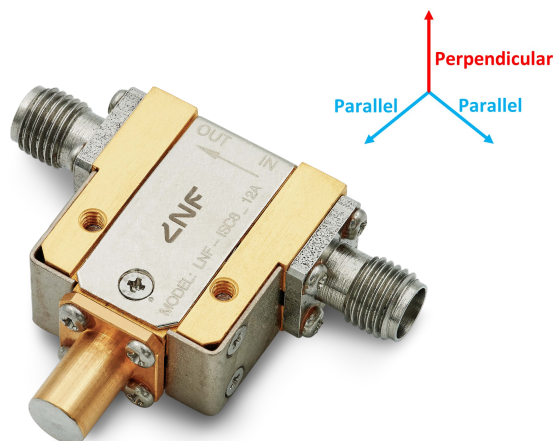

Dimensions without additional shielding

Units: mm

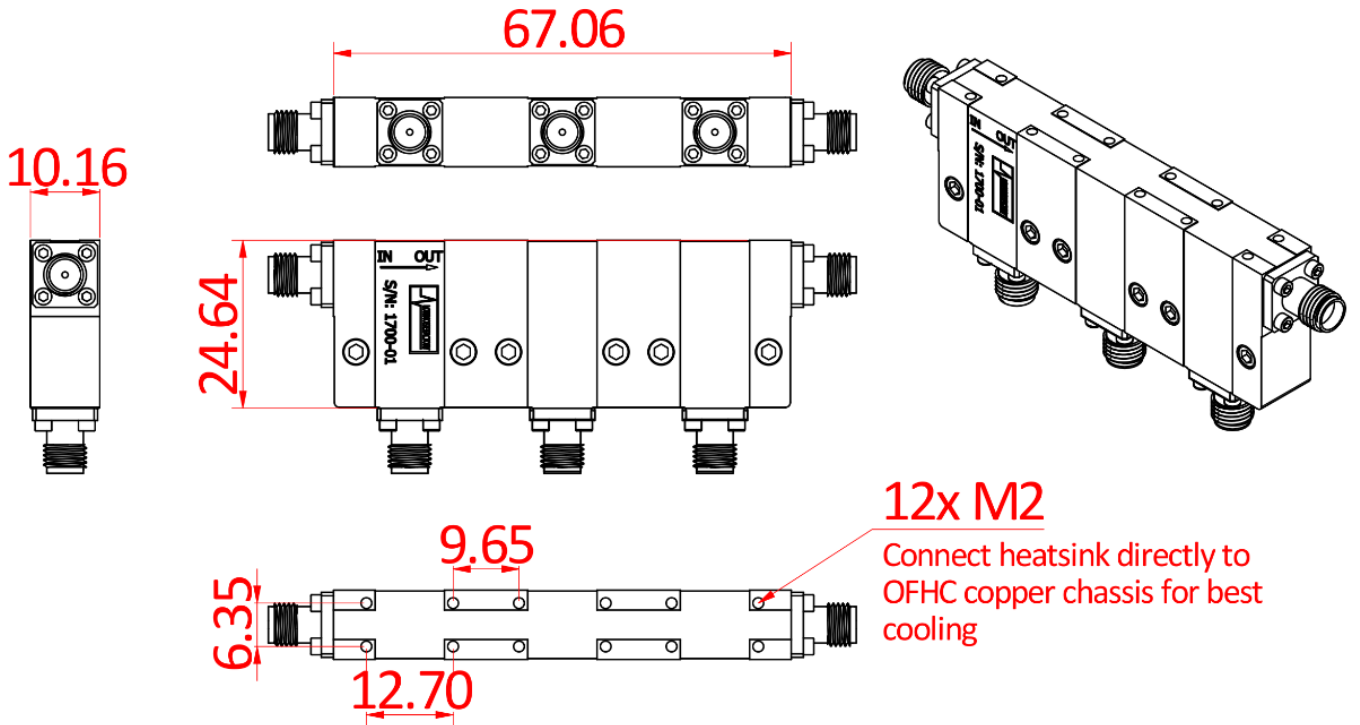

Dimensions with additional shielding

Units: mm

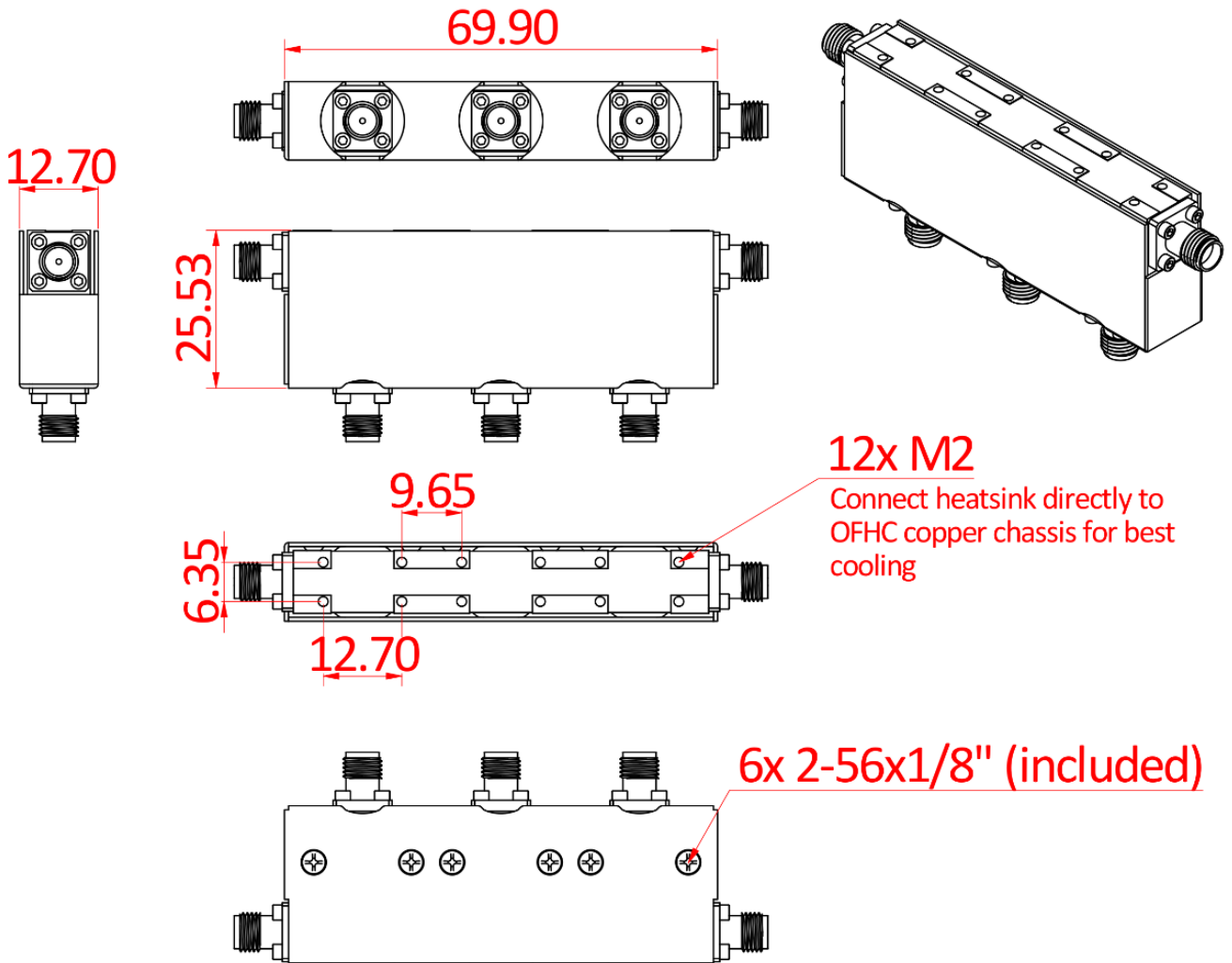

Model numbering

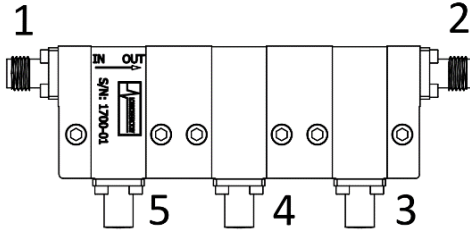

LNF-ISISISC4_12A

Triple Junction Isolator-Isolator-Isolator

Port 1: Female SMA
Port 2: Female SMA
Port 3: Termination
Port 4: Termination
Port 5: Termination

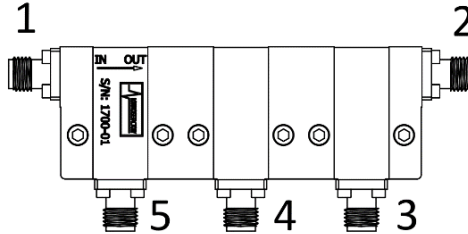

LNF-CICICIC4_12A

Triple Junction Circulator-Circulator-Circulator

Port 1: Female SMA
Port 2: Female SMA
Port 3: Female SMA
Port 4: Female SMA
Port 5: Female SMA

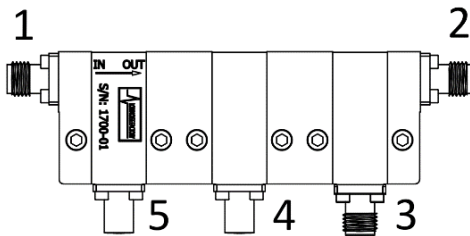

LNF-ISISCIC4_12A

Triple Junction Isolator-Isolator-Circulator

Port 1: Female SMA
Port 2: Female SMA
Port 3: Female SMA
Port 4: Termination
Port 5: Termination

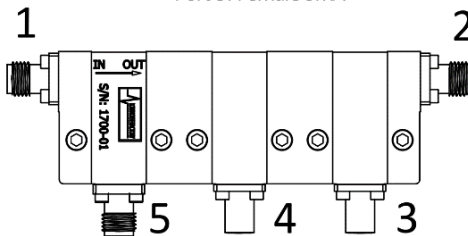

LNF-CIISISC4_12A

Triple Junction Circulator-Isolator-Isolator

Port 1: Female SMA
Port 2: Female SMA
Port 3: Termination
Port 4: Termination
Port 5: Female SMA

Version	Model number
Triple Isolator	LNF-ISISISC4_12A
Triple Circulator	LNF-CICICIC4_12A
Isolator-Isolator-Circulator	LNF-ISISCIC4_12A
Circulator-Isolator-Isolator	LNF-CIISISC4_12A
Extra shield	LNF-SHIELD4_12_TJ