



Specifications:

- WR-10 W-Band Fixed Attenuator
- 75 to 110 GHz
- Attenuation: 30 dB
- Power Dissipation: 0.3W max
- Gold Plated
- Length: 1 Inch
- Waveguide In/Out: WR-10, UG-387/U-M
- Comes with 4 pieces of 4-40 Captive Waveguide Screws



All of our attenuators are high quality, plated with gold and offered at an affordable cost.

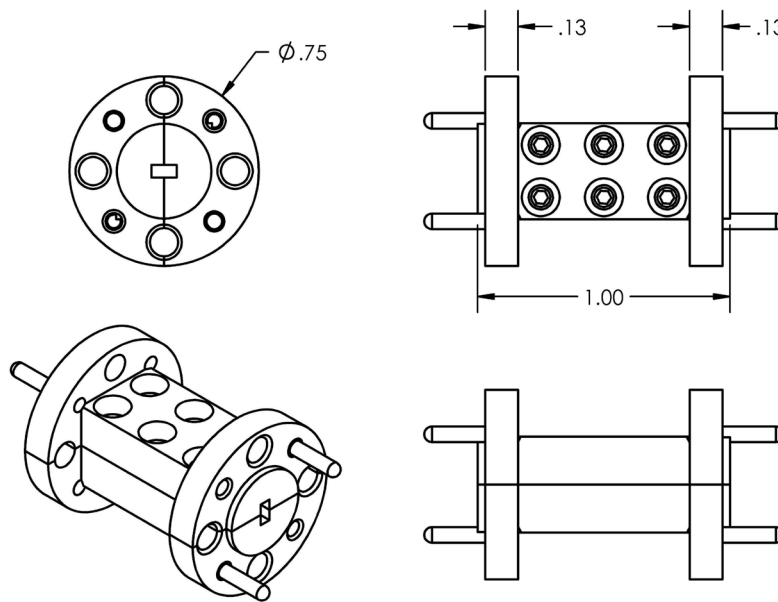

Made in the USA

✉ Sales@QuantumMicrowave.com