



Specifications:

- WR-15 Fixed Attenuator
- Frequency: 50 to 75 GHz
- Attenuation 3 dB
- Power Dissipation: 0.3W max
- Length: 1 inch
- Material: Brass
- Finish: Gold Plated
- Flange: WR-15, UG-387/U
- Comes with 4 pieces of 4-40 Captive Waveguide Screws



All of our attenuators are high quality, plated with gold and offered at an affordable cost.

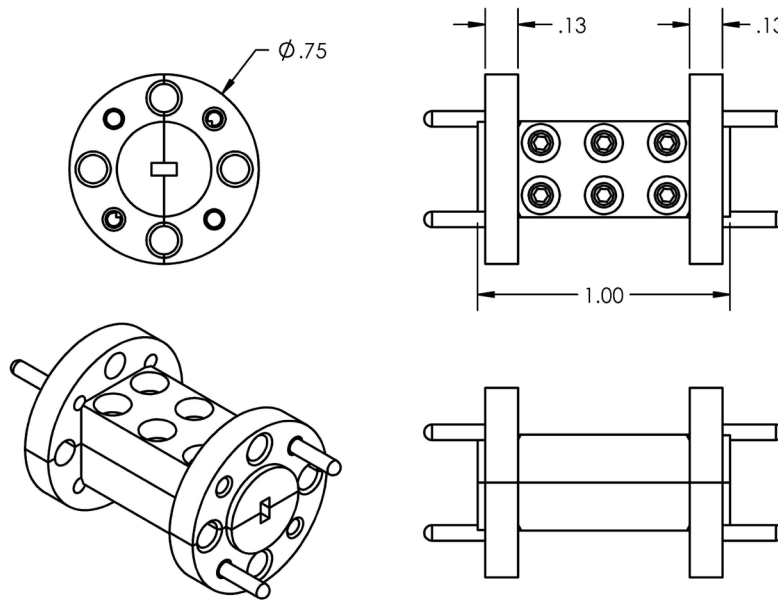

Made in the USA

✉ Sales@QuantumMicrowave.com