



Specifications:

- WR-12 Fixed Attenuator
- Frequency: 60 to 90 GHz
- Attenuation: 10 dB
- Power Dissipation: 0.3W max
- Length: 1 Inch
- Flange Type: UG-387/U
- Material: Aluminum
- Finish: Gold Plated
- Comes with 4 pieces of 4-40 Captive Waveguide Screws



All of our attenuators are high quality, plated with gold and offered at an affordable cost.

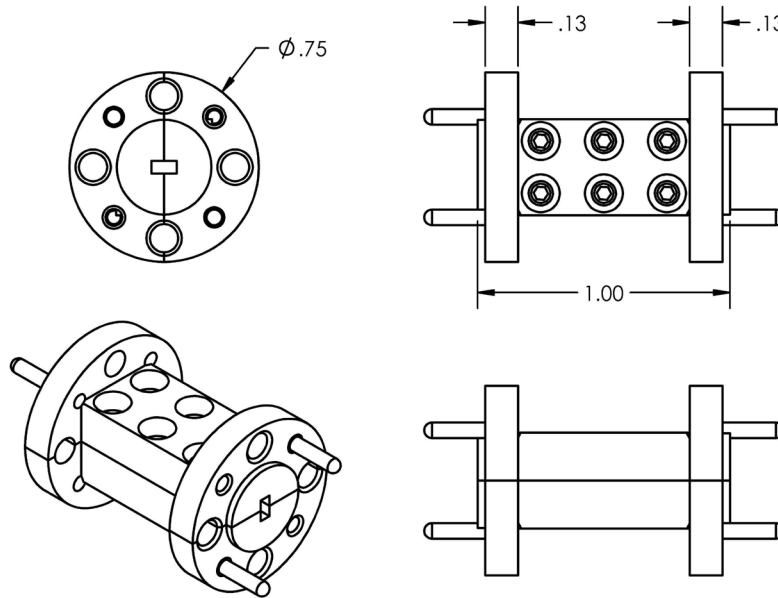

Made in the USA

✉ Sales@QuantumMicrowave.com